



478 MHz RF Saw Filter

Part Number **F4784**

Parameter	Unit	Electrical Specifications		
		Minimum	Typical	Maximum
Center Frequency (Fc)	MHz	-	478.0	-
Insertion Loss	dB	-	3.0	3.5
Pass Bandwidth (BWp)	MHz	4.0	-	-
Amplitude Ripple @BWp	dB	-	1.0	1.5
Absolute Group Delay @Fc	nsec	-	140	-
Group Delay Variation @BWp	nsec	-	160	-
VSWR @BWp	-	-	1.5	-
Ultimate Rejection ~Fc-15MHz ... Fc+25MHz~	dB	45	50	-
Terminating Load Impedance	ohm	-	50	-

Frequency Response

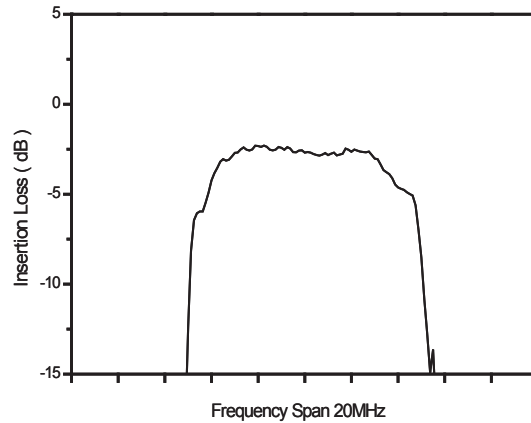
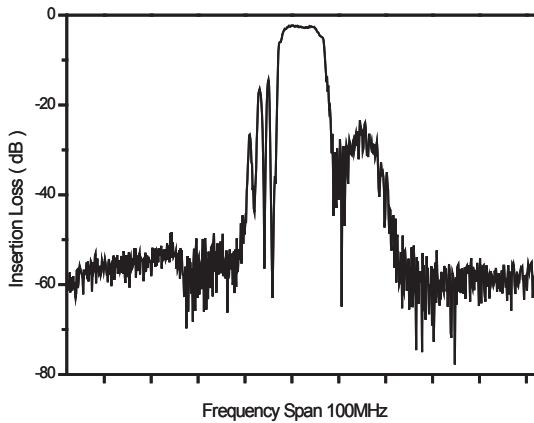

Package Outline

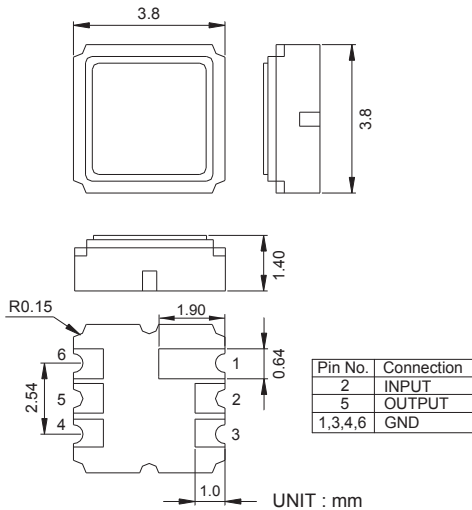

3.8 BY 3.8 SMD PACKAGE

Matching Configuration

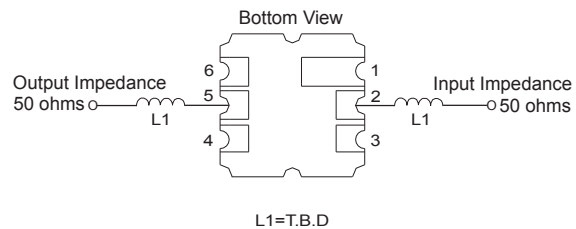

Marking Configuration

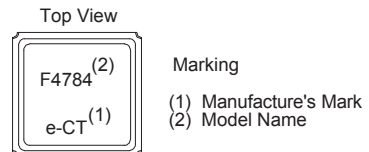

sales@solutechcorp.com