



70 MHz Bandpass Filter  
7.00 MHz Bandwidth

Part Number **502157B**

Parameter	Unit	Electrical Specifications		
		Minimum	Typical	Maximum
Center Frequency	MHz	69.94	70.00	70.06
Insertion Loss	dB	-	21.0	23.0
3dB Bandwidth	MHz	7.00	7.40	-
40dB Bandwidth	MHz	-	8.80	9.00
Passband Ripple	dB	-	0.50	1.00
Group Delay Variation	nsec	-	50	100
Absolute Delay	usec	-	2.73	-
Ultimate Rejection	dB	50	53	-

Maximum Rating				
Maximum Input Power	dBm	-	-	10
Maximum DC Voltage	V	-	-	15
Operating Temperature	°C	-10	25	+60
Storage Temperature	°C	-25	25	+70

Package Outline

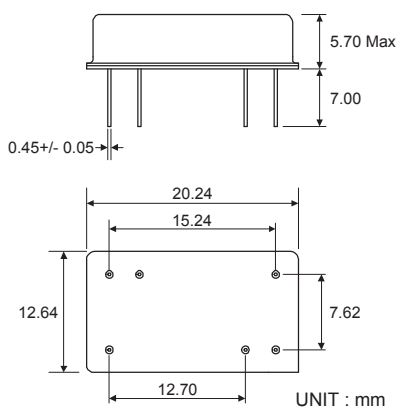

DIP 2012 Version of 6-Pin Dip Package

Matching Configuration

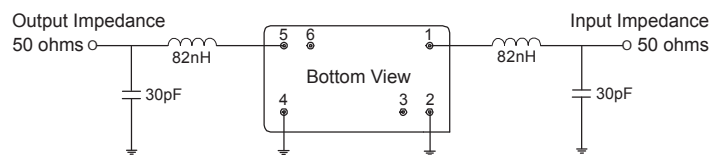

Pin No.	Connection
1	INPUT
5	OUTPUT
others	GND

Marking Configuration

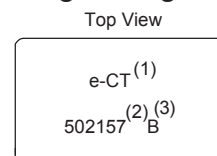

Marking

- (1) Manufacture's Mark
- (2) Model Name
- (3) Revision

sales@solutechcorp.com