



70 MHz Bandpass Filter
8.50 MHz Bandwidth

Part Number **501136B**

Parameter	Unit	Electrical Specifications		
		Minimum	Typical	Maximum
Center Frequency	MHz	69.95	70.00	70.05
Insertion Loss	dB	-	20.05	23.0
1dB Bandwidth	MHz	-	8.07	-
3dB Bandwidth	MHz	8.50	8.80	-
40dB Bandwidth	MHz	-	10.80	11.00
Amplitude Ripple (p-p)	dB	-	0.40	0.70
Group Delay Variation	nsec	-	100	200
Absolute Delay	usec	-	2.31	-
Ultimate Rejection	dB	50	55	-

Frequency Response

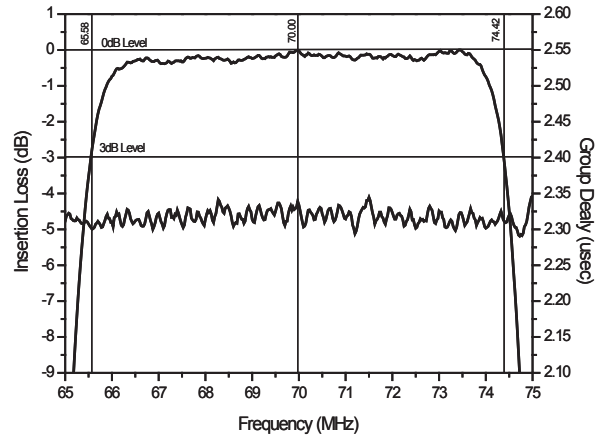
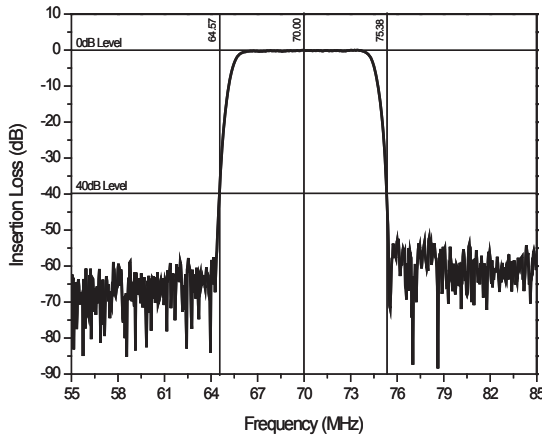

Package Outline

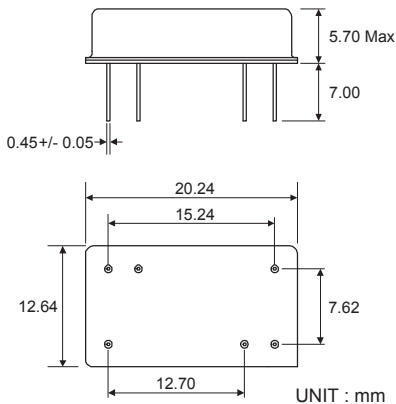

DIP 2012 Version of 6-Pin Dip Package

Matching Configuration

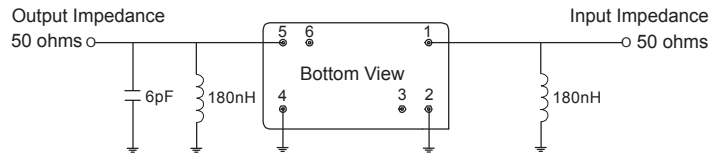

Pin No.	Connection
1	INPUT
5	OUTPUT
others	GND

Marking Configuration

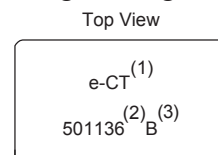

- Marking
- (1) Manufacturer's Mark
 - (2) Model Name
 - (3) Revision

sales@solutechcorp.com